

**DAIKIN**



# INSTALLATION MANUAL

---

## SPLIT SYSTEM Air Conditioners

---

### MODELS

**Ceiling suspended type**

**FHQ18PVJU**

**FHQ24PVJU**

**FHQ30PVJU**

English

Français

Español

Read these instructions carefully before installation.  
Keep this manual in a handy place for future reference.  
This manual should be left with the equipment owner.

Lire soigneusement ces instructions avant l'installation.  
Conserver ce manuel à portée de main pour référence ultérieure.  
Ce manuel doit être donné au propriétaire de l'équipement.

Lea cuidadosamente estas instrucciones antes de instalar.  
Guarde este manual en un lugar a mano para leer en caso de tener alguna duda.  
Este manual debe permanecer con el propietario del equipo.

## CONTENTS





1. SAFETY CONSIDERATIONS .....	2
2. BEFORE INSTALLATION .....	3
3. SELECTING INSTALLATION SITE .....	4
4. PREPARATIONS BEFORE INSTALLATION .....	5
5. INDOOR UNIT INSTALLATION.....	6
6. REFRIGERANT PIPING WORK .....	7
7. DRAIN PIPING WORK .....	9
8. ELECTROLLER .....	10
9. WIRING EXAMPLE AND HOW TO SET THE REMOTE CONTROLLER .....	10
10. ATTACHING THE SUCTION GRILLE, THE DECORATION PANELS AND THE PROTECTION NET .....	12
11. FIELD SETTING .....	12
12. TEST OPERATION .....	13

## 1. SAFETY CONSIDERATIONS

Please read these “SAFETY CONSIDERATIONS” carefully before installing air conditioning equipment and be sure to install it correctly. After completing the installation, make sure that the unit operates properly during the start-up operation. Please instruct the customer on how to operate the unit and keep it maintained.

Also, inform customers that they should store this installation manual along with the operation manual for future reference. This air conditioner comes under the term “appliances not accessible to the general public”.

Meaning of danger, warning, caution and note symbols.

-  **DANGER** .....Indicates an imminently hazardous situation which, if not avoided, will result in death or serious injury.
-  **WARNING** .....Indicates a potentially hazardous situation which, if not avoided, could result in death or serious injury.
-  **CAUTION** .....Indicates a potentially hazardous situation which, if not avoided, may result in minor or moderate injury. It may also be used to alert against unsafe practices.
-  **NOTE** .....Indicates situation that may result in equipment or property-damage-only accidents.

- 
-  **DANGER**
- Do not ground units to water pipes, telephone wires or lightning rods because incomplete grounding could cause a severe shock hazard resulting in severe injury or death, and to gas pipes because a gas leak could result in an explosion which could lead to severe injury or death.
  - Do not install unit in an area where flammable materials are present due to risk of explosion resulting in serious injury or death.

- **Refrigerant gas is heavier than air and displaces oxygen. A massive leak could lead to oxygen depletion, especially in basements, and an asphyxiation hazard could occur leading to serious injury or death.**
- **If the refrigerant gas leaks during installation, ventilate the area immediately.**  
Refrigerant gas may produce toxic gas if it comes in contact with fire such as from a fan, heater, stove or cooking device. Exposure to this gas could result in severe injury or death.
- **After completing the installation work, check that the refrigerant gas does not leak.**  
Refrigerant gas may produce toxic gas if it comes in contact with fire such as from a fan, heater, stove or cooking device. Exposure to this gas could result in severe injury or death.
- **Safely dispose of the packing materials.**  
Packing materials, such as nails and other metal or wooden parts, may cause stabs or other injuries. Tear apart and throw away plastic packaging bags so that children will not play with them. Children playing with plastic bags face the danger of death by suffocation.

---

 **WARNING**

- **Ask your dealer or qualified personnel to carry out installation work. Do not try to install the air conditioner by yourself.**  
Improper installation may result in water leakage, electric shocks or fire.
- **Perform installation work in accordance with this installation manual.**  
Improper installation may result in water leakage, electric shocks or fire.
- **Be sure to use only the specified accessories and parts for installation work.**  
Failure to use the specified parts may result in water leakage, electric shocks, fire or the unit falling.
- **Install the air conditioner on a foundation strong enough to withstand the weight of the unit.**  
A foundation of insufficient strength may result in the equipment falling and causing injuries.
- **Carry out the specified installation work after considering strong winds, typhoons or earthquakes.**  
Improper installation work may result in the equipment falling and causing accidents.
- **Make sure that a separate power supply circuit is provided for this unit and that all electrical work is carried out by qualified personnel according to local laws and regulations and this installation manual.**  
An insufficient power supply capacity or improper electrical construction may lead to electric shocks or fire.
- **Make sure that all wiring is secured, the specified wires are used, and no external forces act on the terminal connections or wires.**  
Improper connections or installation may result in fire.
- **When wiring the power supply and connecting the remote controller wire and transmission wire, position the wires so that the control box lid can be securely fastened.**  
Improper positioning of the control box lid may result in electric shocks, fire or the terminals overheating.

- **Before touching electrical parts, turn off the unit.**
- **Do not touch the switch with wet fingers.**  
Touching a switch with wet fingers can cause electric shock.
- **Be sure to install an earth leakage breaker.**  
Failure to install an earth leakage breaker may result in electric shocks, or fire.
- **Do not install the air conditioner in the following locations :**
  - (a) where a mineral oil mist or an oil spray or vapor is produced, for example in a kitchen.  
Plastic parts may deteriorate and fall off or result in water leakage.
  - (b) where corrosive gas, such as sulfurous acid gas, is produced.  
Corroding copper pipes or soldered parts may result in refrigerant leakage.
  - (c) near machinery emitting electromagnetic waves.  
Electromagnetic waves may disturb the operation of the control system and result in a malfunction of the equipment.
- **Refrigerant pipes may be very hot or very cold during or immediately after operation.**  
Touching them could result in burns or frostbite. To avoid injury give the pipes time to return to normal temperature or, if you must touch them, be sure to wear proper gloves.



#### CAUTION

- **Install drain pipe in order to ensure proper drainage and do the thermal insulation of the pipe in order to prevent condensate.**  
Improper drain pipe may result in water leakage and property damage.
- **Be very careful about product transportation.**  
Some products use PP bands for packaging. Do not use any PP bands for a means of transportation. It is dangerous.
- **Safely dispose of the packing materials.**  
Packing materials, such as nails and other metal or wooden parts, may cause stabs or other injuries.  
Tear apart and throw away plastic packaging bags so that children will not play with them. If children play with a plastic bag which was not torn apart, they face the risk of suffocation.
- **Do not turn off the power immediately after stopping operation.**  
Always wait at least 5 minutes before turning off the power. Otherwise, water leakage and trouble may occur.
- **Make sure to provide for adequate measures in order to prevent that the outdoor unit be used as a shelter by small animals.**  
Small animals making contact with electrical parts can cause malfunctions, smoke or fire. Please instruct the customer to keep the area around the unit clean.



#### NOTE

- **Install the indoor and outdoor units, power supply wire and transmission wire at least 3.5 ft. away from televisions or radios in order to prevent image interference or noise.**  
(Depending on the radio waves, a distance of 3.5 ft. may not be sufficient enough to eliminate the noise.)
- **Remote controller (wireless kit) transmitting distance can result shorter than expected in rooms with electronic fluorescent lamps. (inverter or rapid start types)**  
Install the indoor unit as far away from fluorescent lamps as possible.

- **In a domestic environment this product may cause radio interference in which case the user may be required to take adequate measures.**
- **Dismantling of the unit, treatment of the refrigerant, oil and eventual other parts, should be done in accordance with the relevant local and national regulations.**

## 2. BEFORE INSTALLATION

- **When moving the unit while removing it from the packing case, be sure to lift it by the four hanger brackets. Avoid putting any pressure on other parts especially the refrigerant piping.**
- Be sure to check the type of refrigerant to be used before installing the unit. (Using an incorrect refrigerant will prevent normal operation of the unit.)
- The accessories needed for installation must be retained in your custody until the installation work is completed. Do not discard them!
- Decide upon a line of transport.
- Leave the unit inside its packaging while moving, until reaching the installation site. Where unpacking is unavoidable, use a sling of soft material or protective plates together with a rope when lifting, to avoid damage or scratches to the unit.
- When selecting installation site, refer to the paper pattern.
- For the installation of an outdoor unit, refer to the installation manual attached to the outdoor unit.
- Do not install or operate the unit in rooms mentioned below.
  - **Laden with mineral oil, or filled with oil vapor or spray like in kitchens. (Plastic parts may deteriorate which could eventually cause the unit to fall out of place, or could lead to leaks.)**
  - **Where corrosive gas like sulfurous gas exists.**
  - **(Copper tubing and brazed spots may corrode which could eventually lead to refrigerant leaks.)**
  - **Where machines can generate electromagnetic waves. (Control system may malfunction.)**
  - **Where the air contains high levels of salt such as that near the ocean and where voltage fluctuates greatly such as that in factories. Also in vehicles or vessels.**
- This unit, both indoor and outdoor, is suitable for installation in a commercial and light industrial environment.  
If installed as a household appliance it could cause electromagnetic interference.



#### WARNING

- Entrust installation to the place of purchase or a qualified person. Improper installation could lead to leak and, in worse cases, electric shock or fire.
- Use of unspecified parts could lead to the unit falling, leaks and, in worse cases, electric shock or fire.











#### NOTE

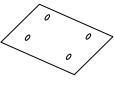

- Be sure to read this manual before installing the indoor unit.
- Be sure to mount an air filter (part to be procured in the field) in the suction air passage in order to prevent water leaking, etc.

## 2-1 ACCESSORIES

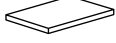
Check the following accessories are included with your unit.

Name	(1) Drain pipe	(2) Metal clamp	(3) Washer for hanger bracket	(4) Clamp
Quantity	1 pc.	1 pc.	8 pcs.	9 pcs.
Shape				

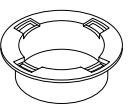
Name	(5) Paper pattern for installation	Insulation pipe cover	Sealing pad
Quantity	1 pc.	1 each	1 each
Shape		(6) For gas pipe  (7) For liquid pipe 	(8) Large  (9) Small 

Name	(10) Resin bush	(11) Insulating tube	(Other) • Operation manual • Installation manual
Quantity	1 pc.	3 pcs.	
Shape		For wire 	

## 2-2 OPTIONAL ACCESSORIES

- The remote controller are required for this indoor unit in Table 1.
- These are 2 types of remote controllers : wired and wireless.  
Select a remote controller according to customer request and install in an appropriate place.

Table 1

Remote controller	
Wired type	BRC1C71
Wireless type	BRC7E83



### NOTE

- If you wish to use a remote controller that is not listed in "Table 1" on page 4, select a suitable remote controller after consulting catalogs and technical materials.

## FOR THE FOLLOWING ITEMS, TAKE SPECIAL CARE DURING CONSTRUCTION AND CHECK AFTER INSTALLATION IS FINISHED.

### a. Items to be checked after completion of work

Items to be checked	If not properly done, what is likely to occur	Check
Are the indoor and outdoor unit fixed firmly?	The units may drop, vibrate or make noise.	
Is the gas leak test finished?	It may result in insufficient cooling.	
Is the unit fully insulated?	Condensate water may drip.	
Does drainage flow smoothly?	Condensate water may drip.	
Does the power supply voltage correspond to that shown on the name plate?	The unit may malfunction or the components burn out.	
Are wiring and piping correct?	The unit may malfunction or the components burn out.	

Is the unit safely grounded?	It may result in electric shock.	
Is wiring size according to specifications?	The unit may malfunction or the components burn out.	
Is something blocking the air outlet or inlet of either the indoor or outdoor units?	It may result in insufficient cooling.	
Are refrigerant piping length and additional refrigerant charge noted down?	The refrigerant charge in the system is not clear.	

### b. Items to be checked at time of delivery

\* Also review the "SAFETY CONSIDERATIONS"

Items to be checked	Check
Did you explain about operations while showing the operation manual to your customer?	
Did you hand the instruction manual over to your customer?	

## 2-3 NOTE TO THE INSTALLER

Be sure to instruct customers how to properly operate the unit (especially cleaning filters, operating different functions, and adjusting the temperature) by having them carry out operations themselves while looking at the manual.

## 3. SELECTING INSTALLATION SITE

Please attach additional insulation pipe cover to the unit body when it is believed that the relative humidity in the ceiling exceeds 80%. Use glass wool, polyethylene foam, or similar with a thickness of 3/8 in. or more as insulation pipe cover.

### (1) Select an installation site where the following conditions are fulfilled and that meets your customer's approval.

- Where optimum air distribution can be ensured.
- Where nothing blocks air passage.
- Where condensate can be properly drained.
- Where the ceiling is strong enough to bear the indoor unit weight.
- Where the false ceiling is not noticeably on an incline.
- Where sufficient clearance for maintenance and service can be ensured.



### DANGER

- Do not install unit in an area where flammable materials are present due to the risk explosion resulting in serious injury or death.



### WARNING

- If the supporting structural members are not strong enough to take the unit's weight, the unit could fall out of place and cause serious injury.

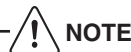

### NOTE

- When a margin is in the space of the \* section, service and maintenance work will become still easier if it vacates 7 7/8 in. or more.

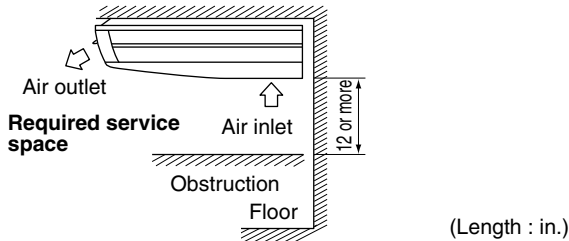
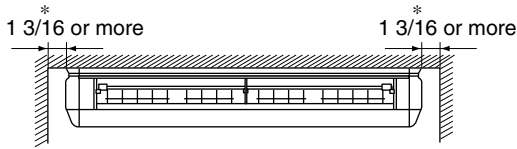

- Where pipe between indoor and outdoor units is possible within the allowable limit.  
(Refer to the installation manual for the outdoor unit.)
- Install the indoor and outdoor units, power wire and connecting wires at least 3.5 ft. away from televisions or radios in order to prevent image interference or noise.  
(Depending on the radio waves, a distance of 3.5 ft. may not be sufficient enough to eliminate the noise.)

- (2) Use suspension bolts for installation. Check whether the ceiling is strong enough to support the weight of the unit or not. If there is a risk, reinforce the ceiling before installing the unit.**  
(Installation pitch is marked on the paper pattern for installation. Refer to it to check for points requiring reinforcing.)
- (3) This product may be installed on ceilings up to 10.6 ft. from the floor.**
- (4) A direction of installation.**
- Refrigerant piping : the rear side, right side or upper part.
  - Wiring : only the rear side.
  - Drain piping : the rear right side or the right side.  
(As the rear left, installation is impossible.)

#### 4. PREPARATIONS BEFORE INSTALLATION

- (1) Relation of holes for indoor unit, suspension bolt position, piping and wiring.**

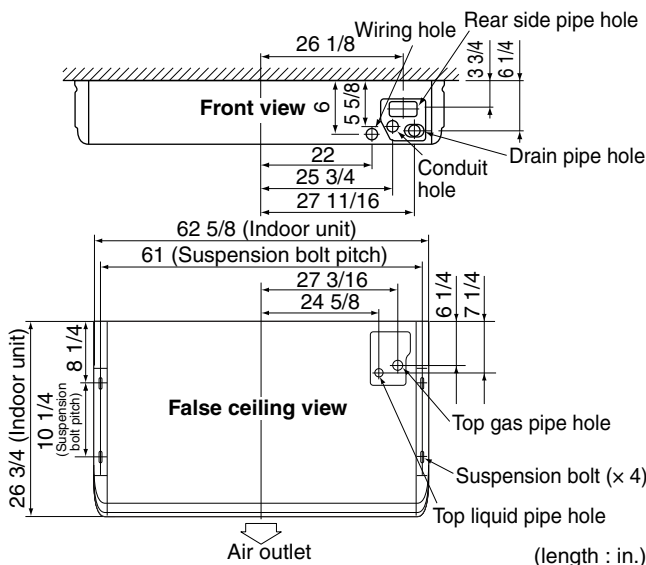

- (2) Make holes for suspension bolts, refrigerant and drain pipe, and wire.**

- Refer to the paper pattern for installation.
- Select the location for each of holes and open the holes in the ceiling.

- (3) Remove the parts from the indoor unit.**

- (3-1) Detach the suction grille.**

- Slide the locking knobs (x2) on the suction grille inward (direction of arrows) and lift upwards. **(Refer to Fig. 1)**
- With the suction grille open, remove the suction grille forward, holding on to the rear tabs (x2) on the suction grille. **(Refer to Fig. 2)**

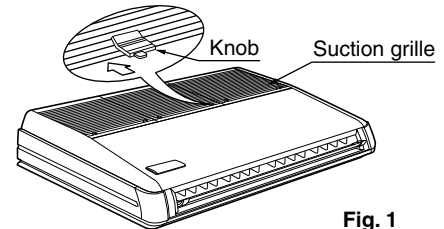

Fig. 1

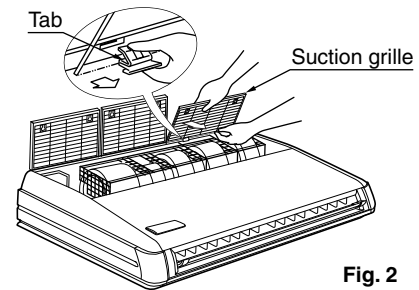

Fig. 2

- (3-2) Remove the decoration panels (left and right) and the protection net.**

- After removing the securing screws for the decoration panels (one each), pull them forward (in the direction of the arrow) and remove them. **(Refer to Fig. 3)**
- Remove the securing screws for the protection net. **(Refer to Fig. 3)**

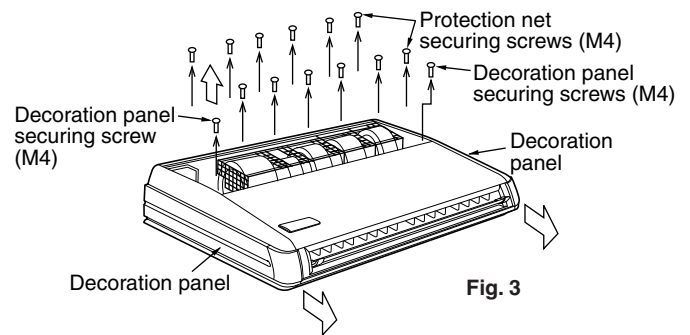

Fig. 3

- Raise one side of the protection net upwards (in the direction of the arrow (i)) and remove back (the arrow (ii)). **(Refer to Fig. 4, 5)**
- Take out the accessories.

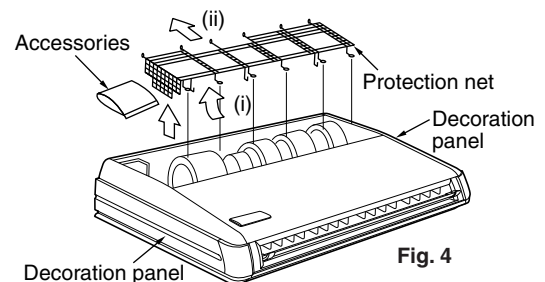

Fig. 4

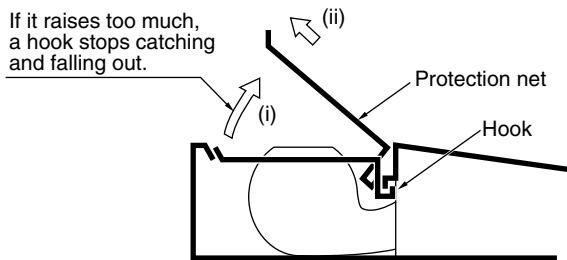

Fig. 5

- (3-3) Remove the rear metal plate for transmission wire, remote controller wire and refrigerant pipe.
- It is necessary to drill the knock out hole in the removable part. Knock down several times with a punch and hammer and remove the removable part with pliers.
  - When setting the refrigerant pipe to the rear side, remove the securing screws and the metal plate. (Refer to Fig. 6).

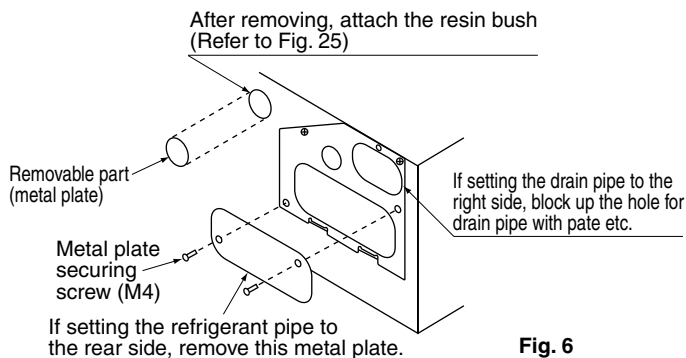

Fig. 6

- (3-4) Remove the hanger brackets.
- Loosen the 2 bolts (M8) used to attach the hanger brackets which are on each side (4 places left and right) to within 3/8 in.. (Refer to Fig. 7, 8)
  - After removing the securing screws (M5) for the hanger brackets which are on the rear side, pull the hanger brackets back (in the direction of the arrow), and remove them. (Refer to Fig. 8)

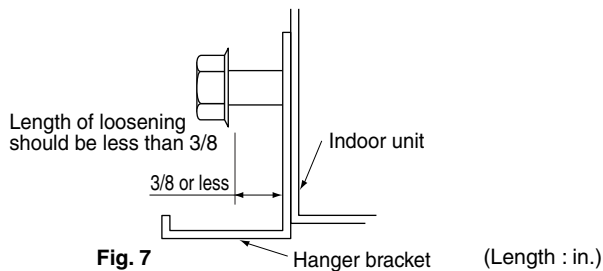

Fig. 7

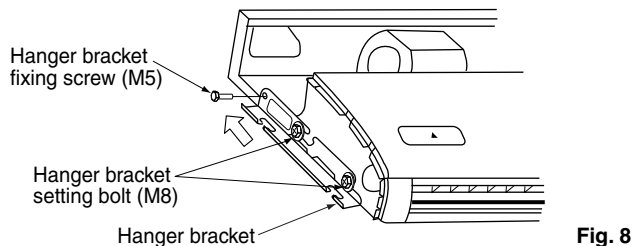

Fig. 8

- (4) Attach the suspension bolts. (Use suspension bolts which are W3/8 or M8-M10 in size.)
- Adjust the distance of the suspension bolts from the ceiling in advance. (Refer to Fig. 9)

**NOTE**

- Use a hole-in anchor for existing ceilings, and a sunken insert, sunken anchor or other field supplied parts for new ceilings to reinforce the ceiling to bear the weight of the unit. Adjust clearance from the ceiling before proceeding further.

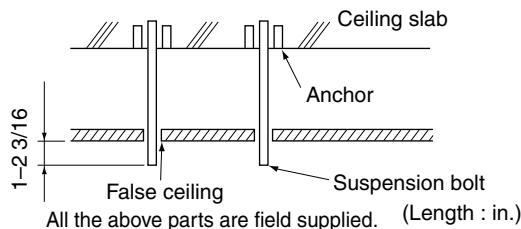

Fig. 9

## 5. INDOOR UNIT INSTALLATION

It may be easier to attach accessory parts before installing the indoor unit. Therefore, please also read the instruction manuals which are provided with the accessory parts.

As for the parts to be used for installation work, be sure to use the provided accessories and specified parts designated by our company.

- (1) Secure the hanger brackets to the suspension bolts. (Refer to Fig. 10)

**NOTE**

- To ensure they are safely secured, use the included washers, and secure them with double nuts to make sure.

- (2) Lift the indoor unit's main body, insert the bolts (M8) for the hanger brackets into the attachment part on the hanger brackets, while sliding the main body from the front. (Refer to Fig. 11)

- (3) Fasten the bolts for the hanger brackets (M8) securely in 4 places, left and right. (Refer to Fig. 11)

- (4) Replace the screws for the hanger brackets which had been removed (M5) securely in 2 places left and right. This is necessary to prevent any forward and back slide in the main body of the indoor unit. (Refer to Fig. 11)

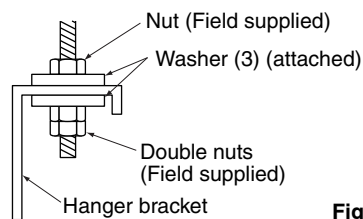

Fig. 10

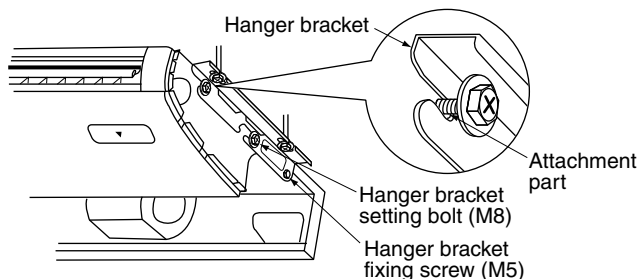

Fig. 11

- (5) When hanging the indoor unit main body, be sure to use a level or a plastic tube with water in it to make sure the drain piping is set either level or slightly tilted, in order to ensure proper drainage. (Refer to Fig. 12)

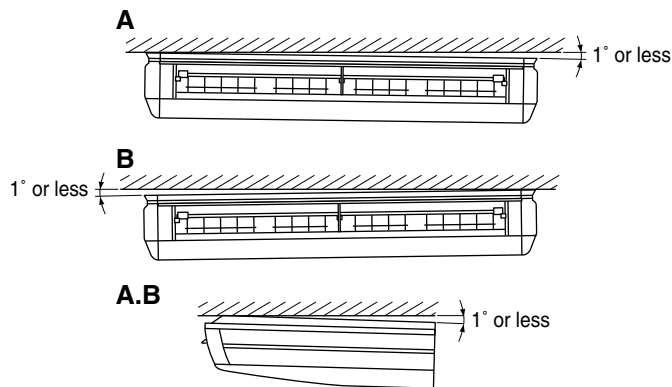

Fig. 12

**A. When the drain piping is tilted to the right, or to the right and back.**

Place it level, or tilt it slightly to the right or the back. (1° or less.)

**B. When the drain piping is tilted to the left, or to the left and back.**

Place it level, or tilt it slightly to the left or the back. (1° or less.)



**CAUTION**

- Setting the unit at an angle opposite to the drain piping might cause a water leakage.

## 6. REFRIGERANT PIPING WORK



**DANGER**

- Refrigerant gas may produce toxic gas if it comes in contact with fire such as from a fan heater, stove or cooking device. Exposure to this gas could cause severe injury or death.



**CAUTION**

- Use a pipe cutter and flare suitable for the type of refrigerant.
- To prevent dust, moisture or other foreign matter from infiltrating the tube, either pinch the end or cover it with tape.
- Do not allow anything other than the designated refrigerant to get mixed into the refrigerant circuit, such as air, etc. If any refrigerant gas leaks while working on the unit, ventilate the room thoroughly right away.

### 6-1 GENERAL INSTRUCTIONS

- For refrigerant pipe of outdoor units, see the installation manual attached to the outdoor unit.
- Execute thermal insulation work completely on both sides of the gas pipe and the liquid pipe.

Otherwise, a water leakage can result sometimes. (The temperature of the gas pipe can reach up to approximately 250°F, so use insulation pipe cover which is sufficiently resistant.)

- Also, in cases where the temperature and humidity of the refrigerant pipe sections might exceed 86°F or RH 80%, reinforce the thermal insulation. (3/4 in. or thicker)

Condensate may form on the surface of the insulation pipe cover.

- Before refrigerant pipe work, check which type of refrigerant is used.

Proper operation is not possible if the types of refrigerant are not the same.

### 6-2 CONNECTING THE REFRIGERANT PIPE

- The outdoor unit is charged with refrigerant.
- Use copper alloy seamless pipes.
- Be sure to use both a spanner and torque wrench together, as shown in the drawing, when connecting or disconnecting pipes to/from the unit. (Refer to Fig. 13)
- Refer to "Table 2" to determine the proper tightening torque.
- Refer to "Table 2" for the dimensions of flare shape.
- When connecting the flare nut, coat the flare section with ester oil or ether oil, rotate three or four times first, then screw in. (Refer to Fig. 14)

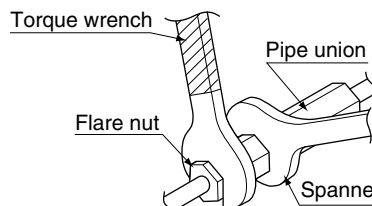

Fig. 13



**CAUTION**

- Be careful for oil not to adhere to any portions other than a flare part. If oil adhere to resin parts etc., there is a possibility of damaging by deterioration.

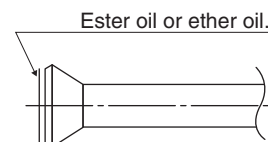

Fig. 14



**NOTE**

- Use the flare nut included with the unit main body.

Table 2

Pipe size (in.)	Tightening torque (ft. lbf)	Flare dimensions A (in.)	Flare shape (in.)
φ3/8	24.1-29.4	0.504-0.520	
φ5/8	45.6-55.6	0.760-0.776	



**CAUTION**

- Overtightening may damage the flare and cause a refrigerant leakage

#### Not recommended but in case of emergency

You must use a torque wrench, but if you are obliged to install the unit without a torque wrench, you may follow the installation method mentioned below.

When you keep on tightening the flare nut with a spanner, there is a point where the tightening torque suddenly increases. From that position, further tighten the flare nut the angle shown below :

Table 3

Pipe size (in.)	Further tightening angle	Recommended arm length of tool (in.)
φ3/8	60 to 90 degrees	Approx. 7 7/8
φ5/8	30 to 60 degrees	Approx. 11 13/16

After the work is finished, make sure to check that there is no gas leak.

### 6-3 BRAZING REFRIGERANT PIPING

**! DANGER**

#### CAUTION TO BE TAKEN WHEN BRAZING REFRIGERANT PIPING

“Do not use flux when brazing refrigerant pipe. Therefore, use the phosphor copper brazing filler metal (BCuP) which does not require flux.”

(Flux has an extremely negative effect on refrigerant piping systems. For instance, if chlorine based flux is used, it will cause pipe corrosion. If the flux contains fluorine, it will damage the refrigerant oil.)

- Before brazing local refrigerant pipe, nitrogen gas shall be blown through the pipe to expel air from the pipe. If you brazing is done without nitrogen gas blowing, a large amount of oxide film develops inside the pipe, and could cause system malfunction.
- When brazing the refrigerant pipe, only begin brazing after having carried out nitrogen substitution or while inserting nitrogen into the refrigerant pipe. Once this is done, connect the indoor unit with a flared or a flanged connection.
- Nitrogen should be set to 2.9 psi with a pressure-reducing valve if brazing while inserting nitrogen into the pipe. (Refer to Fig. 15)

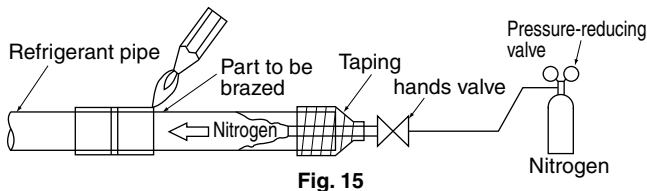

Fig. 15

**! DANGER**

- Use of oxygen may cause an explosion resulting in serious injury or death. Only use nitrogen gas.

**! CAUTION**

- Be sure to insulate any field piping all the way to the piping connection inside the unit. Any exposed piping may cause condensate or a burn if touched.

### 6-4 PIPING INSULATION

- Make absolutely sure to execute thermal insulation works on the pipe-connecting section after checking gas leakage by thoroughly studying the following figure and using the insulation pipe cover (6) and (7). (Fasten both ends with the clamps (4).) (Refer to Fig. 16)
- Wrap the small sealing pad (9) only around the insulation for the joints on the gas piping side. (Refer to Fig. 16)

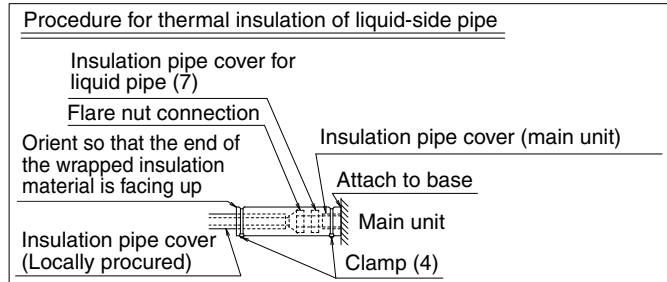
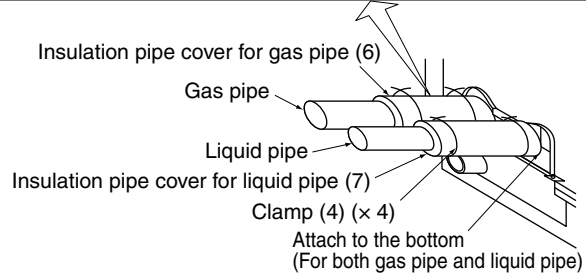
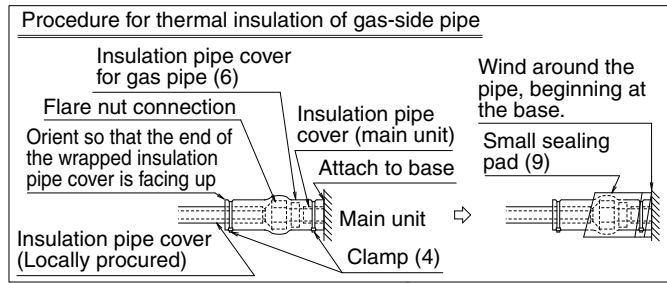

Fig. 16

#### (1) For piping facing back.

- Remove the rear metal plate for pipe. (Refer to Fig. 17)
- The figure of the direction of back shows when both the piping and drain pipe are set backward. When setting the piping to face up or right, attach the rear metal plate for refrigerant pipe and plug a hole for drain pipe. (See “4 PREPARATIONS BEFORE INSTALLATION” (3-3) on page 6)

#### (2) For piping facing up.

- When setting the piping to face up, the L-shaped branch pipe kit sold separately is required.
- Removing the top penetration lid and use the L-shaped branch pipe kit sold separately to set the pipe. (Refer to Fig. 18, 19)

#### (3) For piping facing right.

- Cut out a slit hole on the decoration panel (right) and set the pipe. (Refer to Fig. 17)

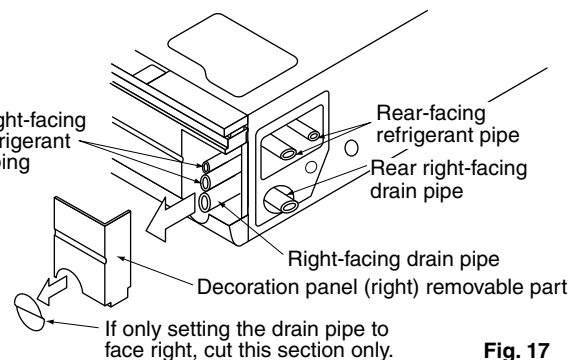
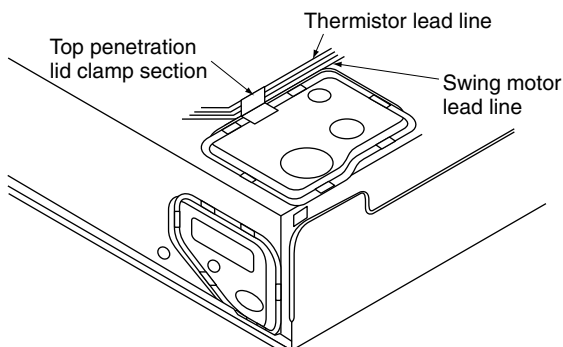
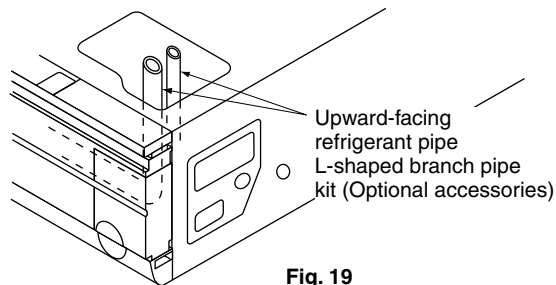
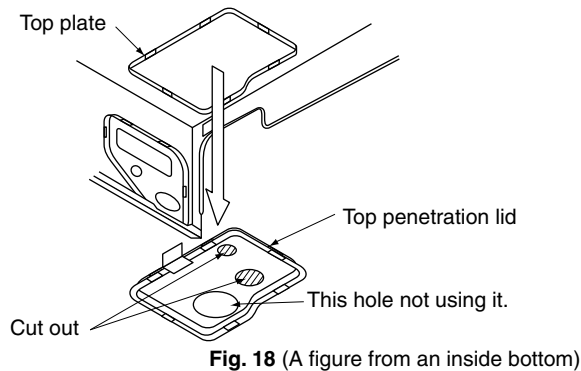

Fig. 17





- When piping is complete, cut the removed penetration lid into the shape of the pipe using scissors and attach. As when before removing the top penetration lid, secure the lead lines for the swing motor and thermistor by passing them through the clamp section on the top penetration lid. **(Refer to Fig. 18, 20)**
- When doing this, block any gaps between the pipe penetration lid and the pipes using putty to prevent dust from entering the indoor unit.

## 7. DRAIN PIPING WORK

### (1) Carry out the drain piping.

- Make sure piping provides proper drainage.
- You can select whether to bring the drain piping out from the rear right or right. For rear right-facing and right-facing situations, refer to "6. REFRIGERANT PIPING WORK" on page 7.
- Make sure the pipe diameter is the same or bigger than the branch piping. (vinyl-chloride piping, nominal diameter 1 in., external diameter 1 1/4 in.)
- Make sure the piping is short, has at least a 1/100 slope, and can prevent air pockets from forming. **(Refer to Fig. 21)**
- Do not allow any slack to gather in the drain pipe inside the indoor unit.  
(Slack in the drain pipe can cause the suction grille to break.)

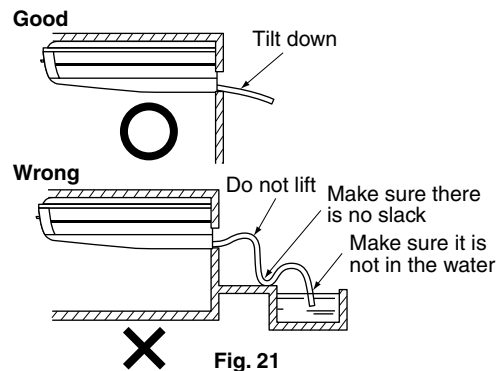

### CAUTION

- Water accumulating in the drain piping can cause the drain to clog.
- Be sure to use the drain pipe (1) and metal clamp (2). Also, insert the drain pipe completely into the drain socket, and securely attach the metal clamp bracket inside the gray tape area on the inserted tip of the drain pipe. **(Refer to Fig. 22)** Screw the screws on the metal clamp bracket until there is 5/32 in. left. (Pay attention to the direction of the attachment to prevent the metal clamp bracket from coming into contact with the suction grille.) **(Refer to Fig. 23)**

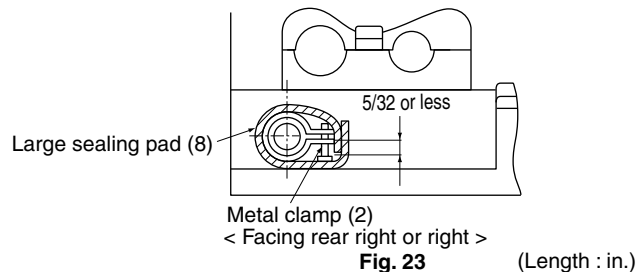
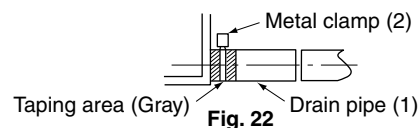

- Insulate the metal clamp bracket and drain pipe from the bottom using the large sealing pad (8). **(Refer to Fig. 23)**
- Be sure to insulate all drain piping running indoors.

### (2) Check to make sure the water flows smoothly after piping is complete.

- Slowly pour 600 ml of drain-checking water into the drain pan through the air outlet.

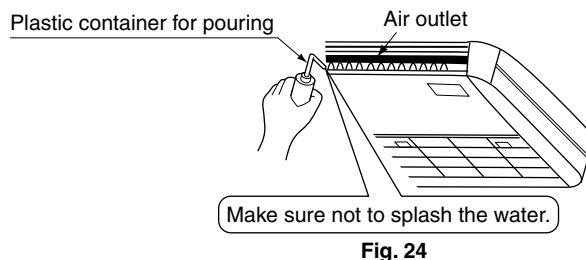

### CAUTION

- Drain piping connections : Do not connect the drain piping directly to sewage pipes that smell of ammonia. The ammonia in the sewage might enter the indoor unit through the drain pipes and corrode the heat exchanger.

- Keep in mind that it will become the cause of getting drain pipe blocked if water collects on drain pipe.

## 8. ELECTRIC WIRING WORK

### 8-1 GENERAL INSTRUCTIONS

- All field supplied parts and materials and electric works must conform to local codes.
- Use copper wire only.
- For electric wiring work, refer to also "Wiring diagram label" attached to the control box lid.
- For remote controller wiring details, refer to the installation manual attached to the remote controller.
- All wires must be performed by an authorized electrician.
- An earth leakage circuit breaker capable of shutting down power supply to the entire system must be installed.
- Refer to the installation manual attached to the outdoor unit for the size of power supply wiring connected to the outdoor unit, the capacity of the circuit breaker and switch, and wiring instructions.
- Be sure to ground the air conditioner.



### DANGER

- Do not ground units to water pipes, telephone wires or lightning rods because incomplete grounding could cause a severe shock hazard resulting in severe injury or death, and to gas pipes because a gas leak could result in an explosion which could lead to severe injury or death.

### 8-2 ELECTRICAL CHARACTERISTICS

Units				Power supply		Fan motor	
Model	Hz	Volts	Voltage range	MCA	MFA	W	FLA
FHQ18PVJU	60	208-230V	Max. 253V Min. 187V	1.3	15	130	1.0
FHQ24PVJU				1.3	15	130	1.0
FHQ30PVJU				1.3	15	130	1.0

MCA : Min. Circuit Amps (A); MFA : Max. Fuse Amps (A)  
W: Fan Motor Rated Output (W); FLA : Full Load Amps (A)

### 8-3 SPECIFICATIONS FOR FIELD SUPPLIED FUSES AND WIRES

Model	Power supply wiring		Remote controller wiring Transmission wiring	
	Field fuses 	Size	Wire	Size
FHQ18PVJU	15A	Wire size must comply with local codes.	Sheathed wire (2 wires)	AWG 18-16
FHQ24PVJU				
FHQ30PVJU				

Allowable length of transmission wire between indoor/outdoor units and between the indoor unit and the remote controller wire are as follows.

- (1) Outdoor unit - Indoor unit : Max. 3280 ft.
- (2) Indoor unit - Remote controller : Max. 1640 ft.

## 9. WIRING EXAMPLE AND HOW TO SET THE REMOTE CONTROLLER

### 9-1 HOW TO CONNECT WIRES



### CAUTION

- Even if the control box lid is removed, pull the remote controller wire, transmission wire and the power supply wire inside the unit using conduits for each, so that the wires do not come into contact with the opening section of the metal casing.
- Pass conduits through the wall and secure along with the refrigerant pipe in order to prevent external pressure being applied to transmission wire and power supply wire.
- To avoid short circuits in the electric parts box, be sure to apply the sealing material or putty (not included) to the wiring hole to prevent the infiltration of water, insects or other small creatures.
- Arrange the wires and fix a lid firmly so that the lid does not float during wiring work.
- Do not clamp remote controller wire and transmission wire together with power supply wire. Doing so may cause malfunction.
- Remote controller wire, transmission wire and power supply wire should be located at least 5 in. from other electric wires. Not following this guideline may result in malfunction due to electrical noise.

### <Method of wiring power supply, units and connecting remote controller wiring> (Refer to Fig. 26)

- Attaching the resin bush  
Attach the resin bush (10) for remote controller wiring.
- Installation of conduit  
Insert the conduit for power supply wire in the conduit hole, and fix it with the lock nut.

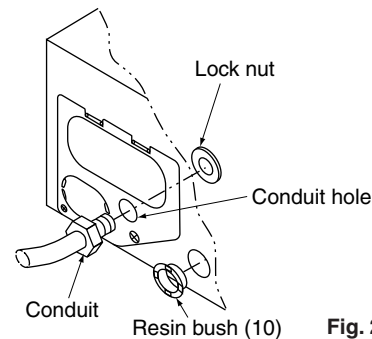

Fig. 25

#### • Power supply wire

Holding the control box lid, loosen the 2 securing screws, remove the control box lid, match up the phases on the power supply terminal block inside (2P), and make the connections. After this is done, use the attached clamp (4) to bind wire between units to the anchor point. (Refer to Fig. 27)

#### • Remote controller wire and transmission wire

Holding the control box lid, loosen the 2 securing screws, remove the control box lid. Thread the remote controller wire and transmission wire through the insulating tube (11) and secure with the clamp (4), and cut off the insulating tube (11) to suitable length. Pull the wires inside through resin bush and connect the wires to the transmission terminal block (6P) inside the control box. After connecting, use the clamp (4) to bind the remote controller wire together with the transmission wire to the anchor. (Refer to Fig. 26, 27, 28)

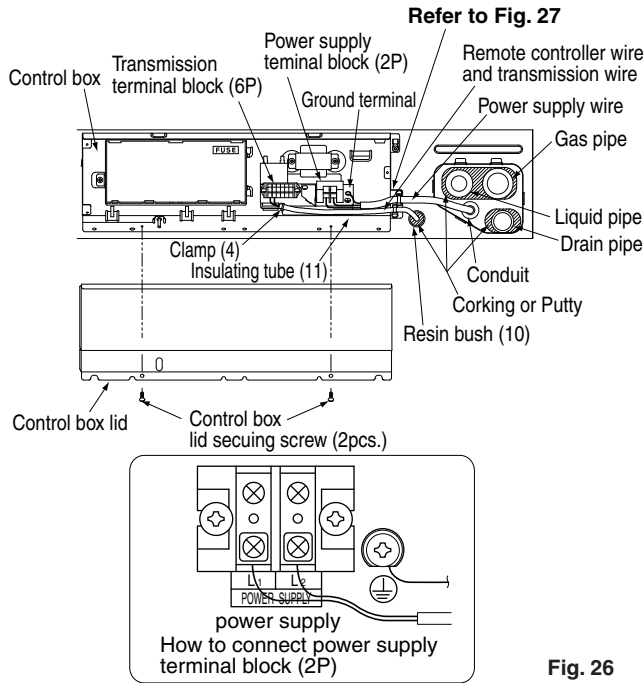

**Fig. 26**

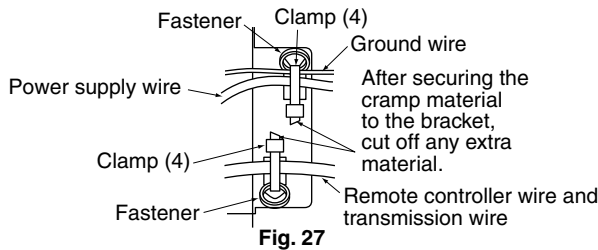

**Fig. 27**

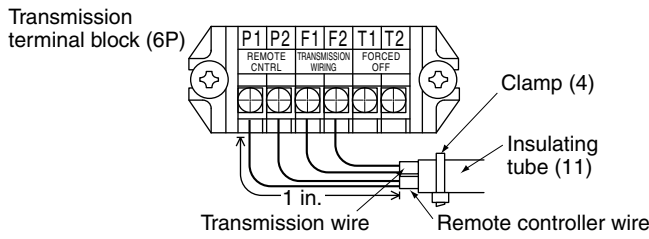

**Fig. 28**

- In the insulating tube (11), it can let the remote controller wire and transmission wire pass to 2.

**! WARNING**

- Never connect power supply wiring to the terminal block for remote controller wiring as this could damage the entire system.
- Use only specified wire and connect wires to the terminal tightly. Be careful wires do not place external stress on terminals. Keep wires in neat order so as to not obstruct other equipment. Make sure that the electric box lid fits tightly. Incomplete connections could result in overheating and, in worse case, result in electric shock or fire.

**! NOTE**

1. Use round crimp-style terminals for connecting wires to the power supply terminal block. If unavailable, observe the following points when wiring.
  - Do not connect wires of different gauge to the same power supply terminal. (Looseness in the connection may cause overheating.)

- Use the specified electric wire. Connect the wire securely to the terminal. Lock the wire down without applying excessive force to the terminal. (Tightening torque: 0.97 ft lbf ±10%)

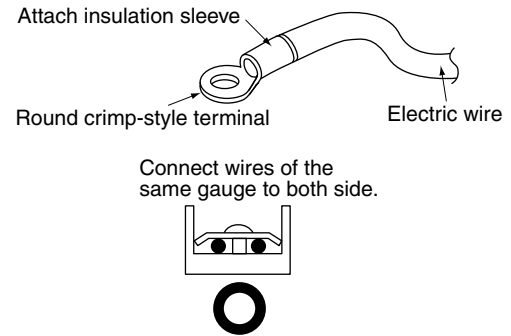

2. Tightening torque for the terminal screws.

- Use the correct screwdriver for tightening the terminal screws. If the blade of screwdriver is too small, the head of the screw might be damaged, and the screw will not be properly tightened.
- If the terminal screws are tightened too hard, screws might be damaged.
- Refer to the table below for the tightening torque of the terminal screws.

**Table 4**

Terminal	Size	Tightening torque (ft-lbf)
Transmission terminal block (6P)	M3.5	0.58 – 0.72
Power supply terminal block (2P)	M4	0.87 – 1.06
Ground terminal	M4	0.87 – 1.06

3. Do not connect wires of different gauge to the same ground terminal. Looseness in the connection may deteriorate protection.
4. Outside of the unit, keep transmission wire at least 5 in. away from power supply wire. The equipment may malfunction if subjected to electrical (external) noise.
5. For remote controller wire, refer to the "INSTALLATION MANUAL OF REMOTE CONTROLLER" attached to the remote controller.

**9-2 WIRING EXAMPLE**

- Fit the power supply wire of each unit with a switch and fuse as shown in the drawing.

**COMPLETE SYSTEM EXAMPLE**

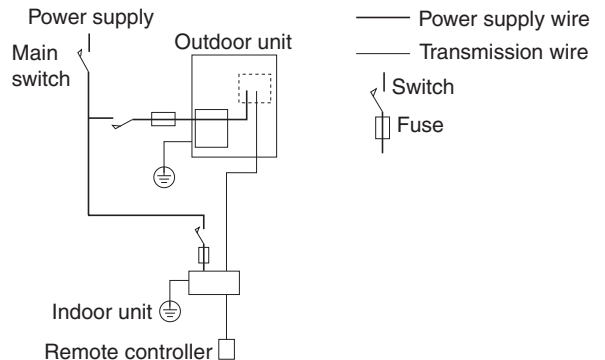

**1. When using 1 remote controller for 1 indoor unit.  
(Normal operation)**

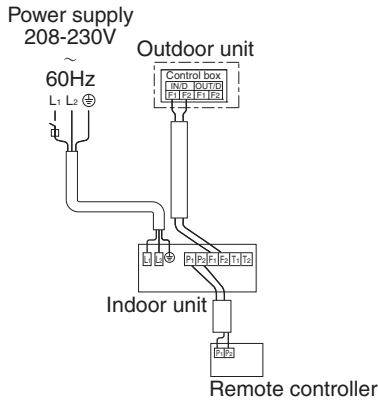

**2. When using 2 remote controllers for 1 indoor unit.**

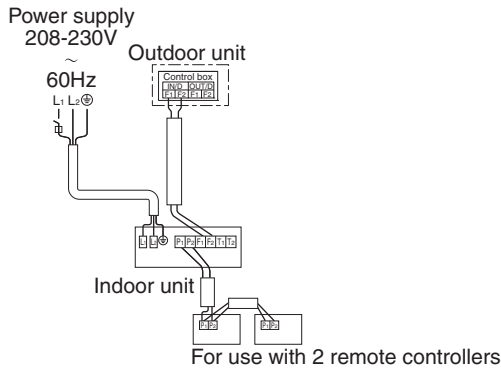

**NOTE**

1. All transmission wires except for remote controller wire are polarized and must match the terminal symbol.
2. A single switch can be used to supply power to units on the same system. However, branch switches and branch circuit breakers must be selected carefully.
3. Do not ground the equipment on gas pipes, water pipes or lightning rods, or crossground with telephones. Improper grounding could result in electric shock.

**10. ATTACHING THE SUCTION GRILLE, THE DECORATION PANELS AND THE PROTECTION NET**

Once wiring is complete, firmly attach the control box lid, the suction grille, the decoration panels and the protection net in the order opposite to detachment.

- Attaching the protection net  
Attach the protection net from the way of the hook (i), fix 2 securing screws of the middle of the other side first (ii), then fix the remaining securing screws (iii).

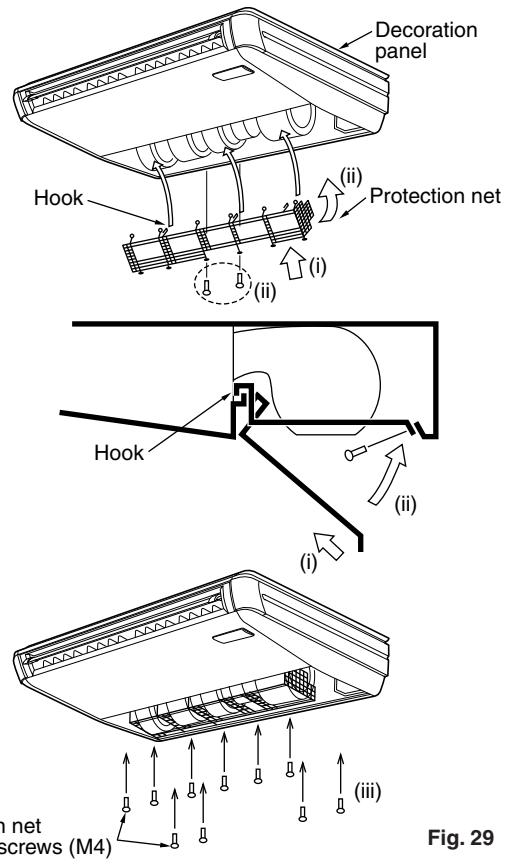

Fig. 29

**11. FIELD SETTING**

**Make sure the control box lids are closed on the indoor and outdoor units, and turn on the power.**

**Field setting must be made from the remote controller in accordance with the installation manual.**

- Setting can be made by changing the “Mode No.,” “FIRST CODE NO.,” and “SECOND CODE NO.”
- For setting and operation, refer to the “FIELD SETTING” in the installation manual of the remote controller.

**11-1 Setting air filter sign**

- Remote controllers are equipped with liquid crystal display air filter signs to display the time to clean air filters.
- Change the SECOND CODE NO. according to “Table 5” depending on the amount of dirt or dust in the room. (SECOND CODE NO. is factory set to “01” for air filter contamination-light.)

Table 5

Setting	Spacing time of display air filter sign (long life type)	Mode No.	FIRST CODE NO.	SECOND CODE NO.
Air filter contamination-light	Approx. 2500 hrs	10 (20)	0	01
Air filter contamination-heavy	Approx. 1250 hrs			02

**<When using wireless remote controllers>**

- When using wireless remote controllers, wireless remote controller address setting is necessary. Refer to the installation manual attached to the wireless remote controller for setting instructions.

## 11-2 2 remote controllers control (Controlling 1 indoor unit by 2 remote controllers)

- When using 2 remote controllers, one must be set to "MAIN" and the other to "SUB".

### MAIN/SUB CHANGEOVER

- Insert a  $\ominus$  screw driver into the recess between the upper and lower part of remote controller and, working from the 2 positions, pry off the upper part.  
The remote controller PC board is attached to the upper part of remote controller. **(Refer to Fig. 30)**
- Turn the MAIN/SUB changeover switch on one of the 2 remote controllers PC boards to "S". (Leave the switch of the other remote controllers set to "M".) **(Refer to Fig. 31)**

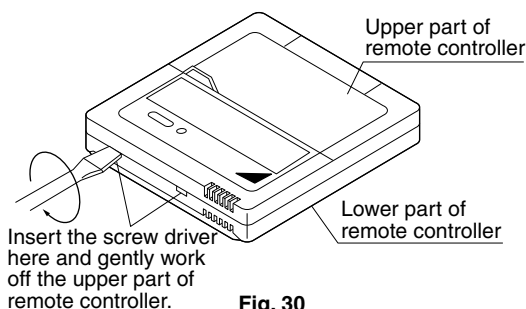

Fig. 30

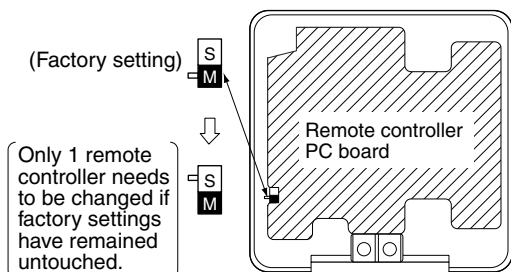

Fig. 31

### Wiring Method

(See "8. ELECTRIC WIRING WORK" and "9. WIRING EXAMPLE AND HOW TO SET THE REMOTE CONTROLLER" on page from 10 to 12.)

- Remove the control box lid.
- Add 2nd remote controller to the transmission terminal block (P1, P2) in the control box. (There is no polarity.)  
(Refer to Fig. 28 on page 11 and Table 4 on page 11)

## 11-3 COMPUTERISED CONTROL (FORCED OFF AND ON/OFF OPERATION)

See "FIELD SETTING" on page 12 for local settings.

- Wire specifications and how to perform wiring  
Connect the input from outside to terminals T1 and T2 of the transmission terminal block.

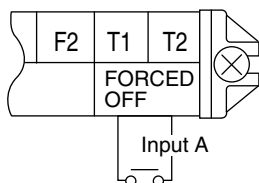

Wire specification	Sheathed vinyl wire or cable (2 wires)
Gauge	AWG 18-16
Length	Max. 328 ft.
External terminal	Contact that can ensure the minimum applicable load of 15 V DC, 10 mA.

- Actuation
  - The following table explains FORCED OFF and ON/OFF OPERATIONS in response to Input A.

FORCED OFF	ON/OFF OPERATION
Input "ON" stops operation (impossible by remote controllers.)	Input OFF → ON turns ON unit.
Input OFF enables control by remote controller.	Input ON → OFF turns OFF unit.

- How to select FORCED OFF and ON/OFF OPERATION
  - Turn the power on and then use the remote controller to select operation.

## 11-4 CENTRALIZED CONTROL

- For centralized control, it is necessary to designate the group No. For details, refer to the manual of each optional controllers for centralized control.

## 12. TEST OPERATION

Refer to the section of "FOR THE FOLLOWING ITEMS, TAKE SPECIAL CARE DURING CONSTRUCTION AND CHECK AFTER INSTALLATION IS FINISHED." on page 4.

- Make sure if the service lids are closed on the indoor and outdoor units.
- After finishing the construction of refrigerant pipe, drain pipe and electric wire, conduct the check operation referring to the installation manual of the outdoor unit.
- The operation lamp of the remote controller will flash when a malfunction occurs. Check the malfunction code on the liquid crystal display to identify the point of trouble. An explanation of malfunction codes and the corresponding trouble is provided in the installation manual of the outdoor unit.  
If any of the items in Table 6 are displayed, there may be a problem with the wiring or power, so check the wiring again.

Table 6

Remote control display	Content
"  " (under centralized control) is lit up	<ul style="list-style-type: none"> <li>There is a short circuit at the FORCED OFF terminals (T1, T2)</li> </ul>
"U4" is lit up "UF" is lit up	<ul style="list-style-type: none"> <li>The power on the outdoor unit is off.</li> <li>The outdoor unit has not been wired for power supply.</li> <li>Incorrect wiring for the transmission wiring and / or FORCED OFF wiring.</li> <li>The transmission wiring is cut.</li> </ul>
No display	<ul style="list-style-type: none"> <li>The power on the indoor unit is off.</li> <li>The indoor unit has not been wired for power supply.</li> <li>Incorrect wiring for the remote controller wiring, the transmission wiring and / or the FORCED OFF wiring.</li> <li>The remote controller wiring is cut.</li> </ul>

- If "U3" is lit up, the malfunction code shows the check operation has not been performed yet.

## 12-1 HOW TO DIAGNOSE FOR MALFUNCTION

With the power on, it is possible to monitor the type of malfunction by looking at the malfunction code displayed in the remote controller.

If nothing is displayed in the remote controller, check the following items before attempting a diagnosis based on the malfunction code, as they might be a cause.

- Disconnected or incorrect wiring (between power supply and the outdoor unit, between the outdoor and indoor units, and between the indoor unit and the remote controller)
- Burnt out indoor or outdoor unit fuse
- “ 88 ” will be displayed for a few seconds on the remote controller immediately after the power is turned on.  
This display indicates that the remote controller is being checked to see whether it is ok or not, and does not indicate a malfunction.

#### Diagnose with the display on the liquid crystal display remote controller.

##### 1. With the wired remote controller. (NOTE 1)

When the operation stops due to trouble, operation lamp flashed, and “  ” and the malfunction code are indicated in the liquid crystal display. In such a case, diagnose the fault contents by referring to the table on the malfunction code list. In case of group control, the unit No. is displayed so that the indoor unit No. with the trouble can be recognized. (NOTE 2).

##### 2. With the wireless remote controller.

(Refer also to the operation manual attached to the wireless remote controller)

When the operation stops due to trouble. the display on the indoor unit flashes. In such a case, diagnose the fault contents with the table on the malfunction code list looking for the malfunction code which can be found by following procedures. (NOTE 2)

- (1) Press the INSPECTION /TEST OPERATION button, “  ” is displayed and “ 0 ” flashes.
- (2) Press the PROGRAMMING TIME button and find the unit No. which stopped due to trouble.  
Number of beeps

3 short beeps Perform all the following operations



1 short beep Perform (3) and (6)

1 long beep No trouble

- (3) Press the OPERATION MODE SELECTOR button and upper figure of the malfunction code flashes.
- (4) Continue pressing the PROGRAMMING TIME button unit it makes 2 short beeps and find the upper code.
- (5) Press the OPERATION MODE SELECTOR button and lower figure of the malfunction code flashes.
- (6) Continue pressing the PROGRAMMING TIME button unit it makes a long beep and find the lower code.
  - A long beep indicate the malfunction code.

#### NOTE

1. In case wired remote controller. Press the INSPECTION / TEST OPERATION button on remote controller, “  ” starts flashing.
2. Keep down the ON/OFF button for 5 seconds or longer in the inspection mode and the above trouble history disappears, after the trouble code goes on and off twice, followed by the code “ 88 ”(normal).  
The display changes from the inspection mode to the normal mode.

Order	Operation
(1)	Open gas side stop valve.
(2)	Open liquid side stop valve.
(3)	Electrify crank case heater for 6 hours.
(4)	Set to cooling with the remote controller and push “ ON/OFF ” button to start operation.
(5)	Push“  /TEST ”button twice and operate in TEST OPERATION MODE for 3 minutes.
(6)	Push“  ”button and confirm its operation.
(7)	Push“  /TEST ”button and operate normally.
(8)	Confirm its function according to the operation manual.

## 12-2 MALFUNCTION CODE

- For places where the malfunction code is left blank, the “  ” indication is not displayed. Though the system continues operating, be sure to inspect the system and make repairs as necessary.
- Depending on the type of indoor or outdoor unit, the malfunction code may or may not be displayed.

Code	Malfunction/Remarks
A1	Indoor unit's PC board faulty
A3	Condensate level abnormal
A6	Indoor fan motor overloaded, overcurrent or locked.
A7	Air flow direction adjust motor is fault.
A9	Drive for electronic expansion valve is fault.
AJ	Type set improper
	Capacity data is wrongly preset. Or there is nothing programmed in the data hold IC.
C4	Sensor R2T for heat exchanger temperature is fault.
C5	Sensor R3T for heat exchanger temperature is fault.
C9	Sensor R1T for suction air temperature is fault.
CJ	Sensor for remote controller is fault.
	The remote controller thermistor does not function, but the system thermo run is possible.
E3	High pressure abnormal (outdoor unit)
E4	Low pressure abnormal (outdoor unit)
E5	Compressor motor lock malfunction
E7	Outdoor fan motor lock malfunction Outdoor fan instantaneous overcurrent malfunction
E9	Electronic expansion valve faulty (outdoor unit)
F3	Discharge pipe temperature abnormal (outdoor unit)
F6	The refrigerant is overcharged.
H9	Outdoor air thermistor faulty (outdoor unit)
J3	Discharge pipe thermistor faulty (outdoor unit)
J5	Suction pipe thermistor faulty (outdoor unit)
J6	Heat exchanger thermistor faulty (outdoor unit)
J9	Sensor for heat exchanger is fault.
JA	Sensor for high pressure is fault.
JC	Sensor for low pressure is fault.
L4	Overheated heat-radiating fin (outdoor)
	Inverter cooling defect.

L5	Instantaneous overcurrent (outdoor)
	Possible earth fault or short circuit in the compressor motor.
L8	Electric thermal (outdoor)
	Possible electrical overload in the compressor or cut line in the compressor motor.
L9	Stall prevention (outdoor)
	Compressor possibly locked.
LC	Transmission malfunction between the outdoor control units' inverters (outdoor)
P1	Open-phase (outdoor)
P3	PC board temperature sensor malfunction (outdoor)
P4	Heat-radiating fin temperature sensor malfunction (outdoor)
PJ	Type set improper (outdoor unit)
	Capacity data is wrongly preset. Or there is nothing programmed in the data hold IC.
U0	Suction pipe temperature abnormal
U2	Power source voltage malfunction
	Includes the defect in K1M.
U3	The check operation has not performed.
U4 UF	Transmission error (indoor unit - outdoor unit)
	Miswiring between indoor and outdoor units or malfunction of the PC board mounted on the indoor and the outdoor units. If UF is shown, the wire between the indoor and outdoor units is not properly wired. Therefore, immediately disconnect the power supply and correct the wire. (The compressor and the fan mounted on the outdoor unit may start operation independent of the remote controller operation.) The power is not supplied to outdoor unit.
U9	Same transmission for in / outdoor unit is fault.
UA	Miss setting for multi system
	Setting is wrong for selector switch of multi-system. (see switch SS2 on the main unit's PC board)

**DAIKIN AC (AMERICAS), INC.**

1645 Wallace Drive, Suite 110  
Carrollton, TX 75006

info@daikinac.com  
www.daikinac.com

**DAIKIN INDUSTRIES, LTD.**

Head office:  
Umeda Center Bldg., 2-4-12, Nakazaki-Nishi,  
Kita-ku, Osaka, 530-8323 Japan

Tokyo office:  
JR Shinagawa East Bldg., 2-18-1, Konan,  
Minato-ku, Tokyo, 108-0075 Japan

